

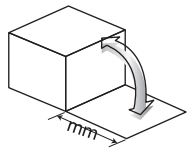

說明書

# Bearing Capacity Instruction

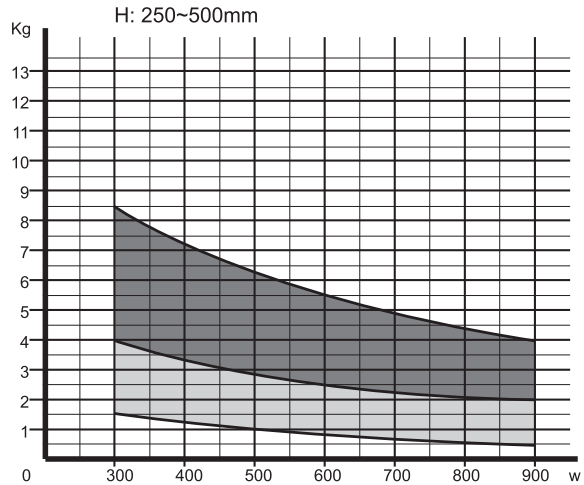

Use one

Use two together

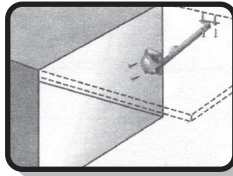

1. Put screws on the wood plate.

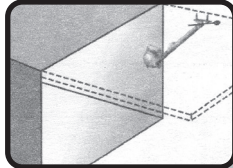

2. Put the Body of the arm on the fixing plate.

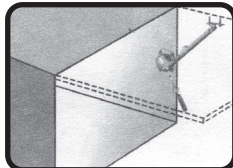

3. Adjust the screws of the Body to the point.

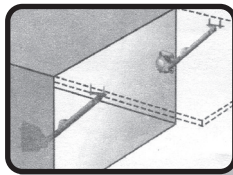

4. It is possible to install on both sides.

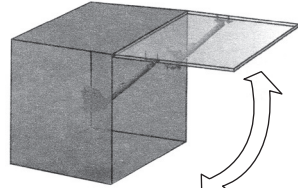
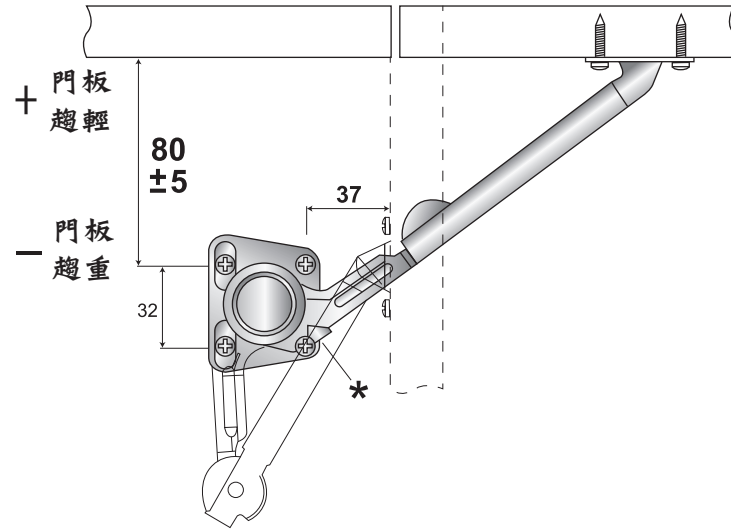
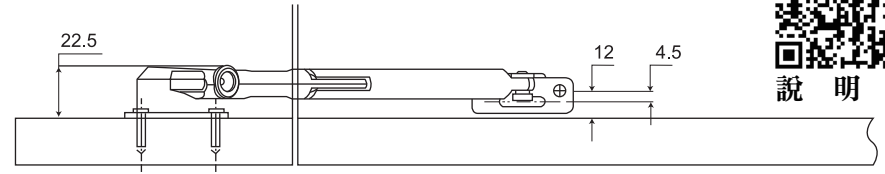

Figure 1. Push up

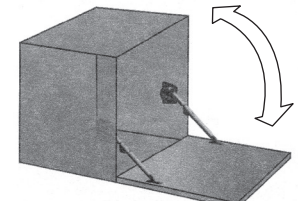

Figure 2. Suspend

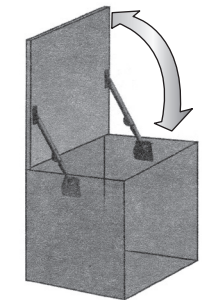

Figure 3. Uncover

## 建議事項

門片如超過3公斤以上

最好左右邊掀桿皆用，

增強掀起平衡力與穩定

性可避免鉸鍊鬆損

，提高產品使用性。

## Soft Down Stay

Type:

Steel, zinc alloy, surface nickel plated  
Adjust\* screws to attain the best result  
Three installation results(See Figures)

